Installation and Service Guide

Publication number E3491-97002
July 1997

For Safety information, Warranties, and Regulatory information, see the pages behind the index.

© Copyright Hewlett-Packard Company 1994-1997
All Rights Reserved

HP E3491B Pentium Processor Probe

HP E3491B Pentium Processor Probe—At a Glance

The HP E3491B Pentium processor probe provides a low-cost way to debug embedded software for Intel Pentium® microprocessors. It can also be used with the HP E2457A Preprocessor Interface for microprocessor code disassembly.

The target connection

The HP E3491B Pentium processor probe connects to your target microprocessor via a special connector on the target system, or through the HP E2457A Preprocessor Interface.

The HP 16505A connection

The HP E3491B Pentium processor probe connects to the HP 16505A Prototype Analyzer via an Ethernet LAN for remote operation, or directly for point-to-point operation. The logic analyzer connects to the HP 16505A through a SCSI connector.

The configuration switches

Use the switches to configure communication to the HP 16505A. There is a guide to these switches on the bottom of the HP E3491B Pentium Probe.

The status LEDs

LEDs show the status of the power supply, the target system, and the connection to the HP 16505A.

Compatibility with other products

The HP E3491B Pentium processor probe and HP 16505A Prototype Analyzer can also be used with the HP E2457A Preprocessor Interface.

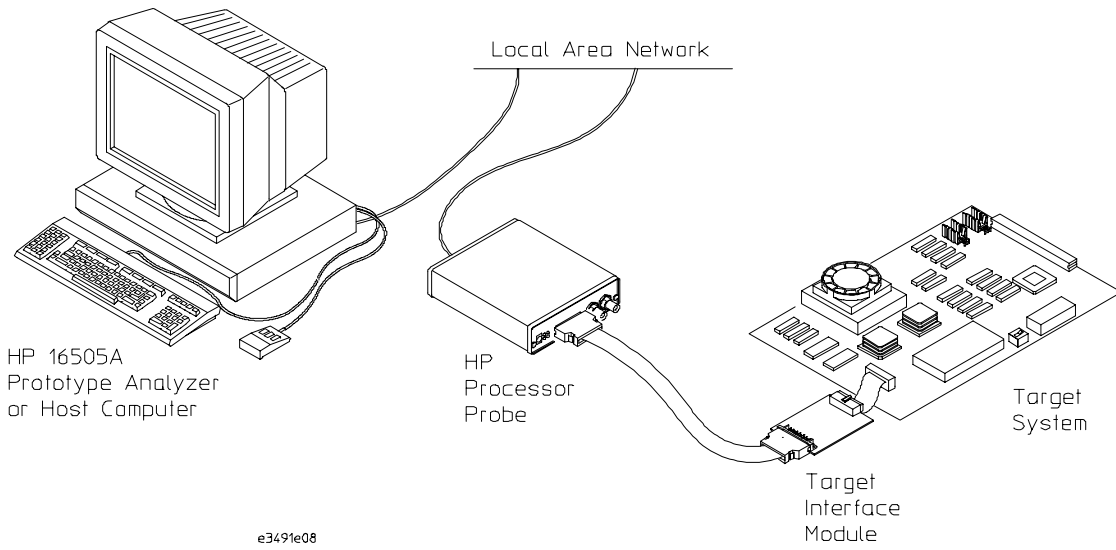

e3491e08

Contents

1 Overview 1

Equipment Used with the Processor Probe 2

Equipment Supplied 3

Minimum Equipment Required 4

System Configurations 5

HP Prototype Analyzer 5

HP Logic Analyzer 6

No Logic Analyzer 7

Power-On/Power-Off Sequence 8

To power on the system 8

To power off the system 8

To connect the processor probe to a power source 9

Connection Sequence 10

2 Connecting the Processor Probe to a PC or Workstation 11

Setting Up a LAN Connection to a PC or Workstation 13

To obtain an IP address 14

To configure LAN parameters using the built-in terminal interface 15

To configure LAN parameters using BOOTP 18

To set the 10BASE-T configuration switches 20

To verify LAN communications 21

Setting Up a Serial Connection 22

To set the serial configuration switches 23

To connect a serial cable 23

To verify serial communications 25

Setting up Debugger Software 26

3 Connecting the Processor Probe to an HP 16505A Prototype Analyzer 27

Connecting the Probe to the Prototype Analyzer 29

Connecting for a point-to-point configuration 30

Connecting to a LAN 31

To set the 10BASE-T configuration switches 32

Setting Up LAN Communication 33

To set the LAN address of the processor probe using the Run Control tool 33

To verify LAN communications 34

4 Connecting to the Target System 35

To test the HP E3491B Pentium processor probe 36

To connect to a target system via the Intel defined debug port 37

To connect to a target system via the HP E2457A Pentium Preprocessor 39

5 Configuring the Processor Probe 41

To configure using the Run Control tool 43

To configure using the built-in commands 44

To configure using a debugger 44

To configure restriction to real-time runs 45

To configure the Trigger Out BNC 46

To configure the Trigger In BNC 46

To configure branch trace messaging 47

To configure breaks on processor read/write to debug registers 47

To configure INIT behavior 48

To configure RESET behavior 49

6 Designing a Target System 51

Designing a target system for use with the HP E2457A Preprocessor Interface 52

Designing a target system for use with the Intel-defined debug port 53

Planning INIT and RESET operation 53

APIC interrupts 53

7 Specifications and Characteristics 55

Processor Compatibility 56
Electrical Specifications 56
Environmental Specifications 59
Pinout for 30-pin Debug Port 60

8 Updating Firmware 61

To update firmware using the HP prototype analyzer 63
To update firmware using prgflash.xxx 64
To run prgflash.xxx on Unix workstations 65
To run prgflash.exe on Windows 95 or Windows NT 65
To display current firmware version information 66
If the firmware doesn't appear to be updated 67
If there is a power failure during a firmware update 67

9 Solving Problems 69

Troubleshooting Guide 71

Status Lights 72

Built-in Commands 74

Problems with the LAN Interface 76

If you cannot verify LAN communication 76

If you have LAN connection problems 77

If the "POL" LED is lit 78

If it takes a long time to connect to the network 78

Problems with the Serial Interface 79

If you cannot verify RS-232 communication 79

If you have RS-232 connection problems with the MS Windows Terminal program 79

Contents

Problems with the Processor Probe Itself 81

To run the power up self test 81

To execute the built-in performance verification test 83

If a performance verification test fails 86

Returning the Parts to Hewlett-Packard for Service 89

To return a part to Hewlett-Packard 89

To obtain replacement parts 90

To clean the processor probe 90

Overview

Equipment Used with the Processor Probe

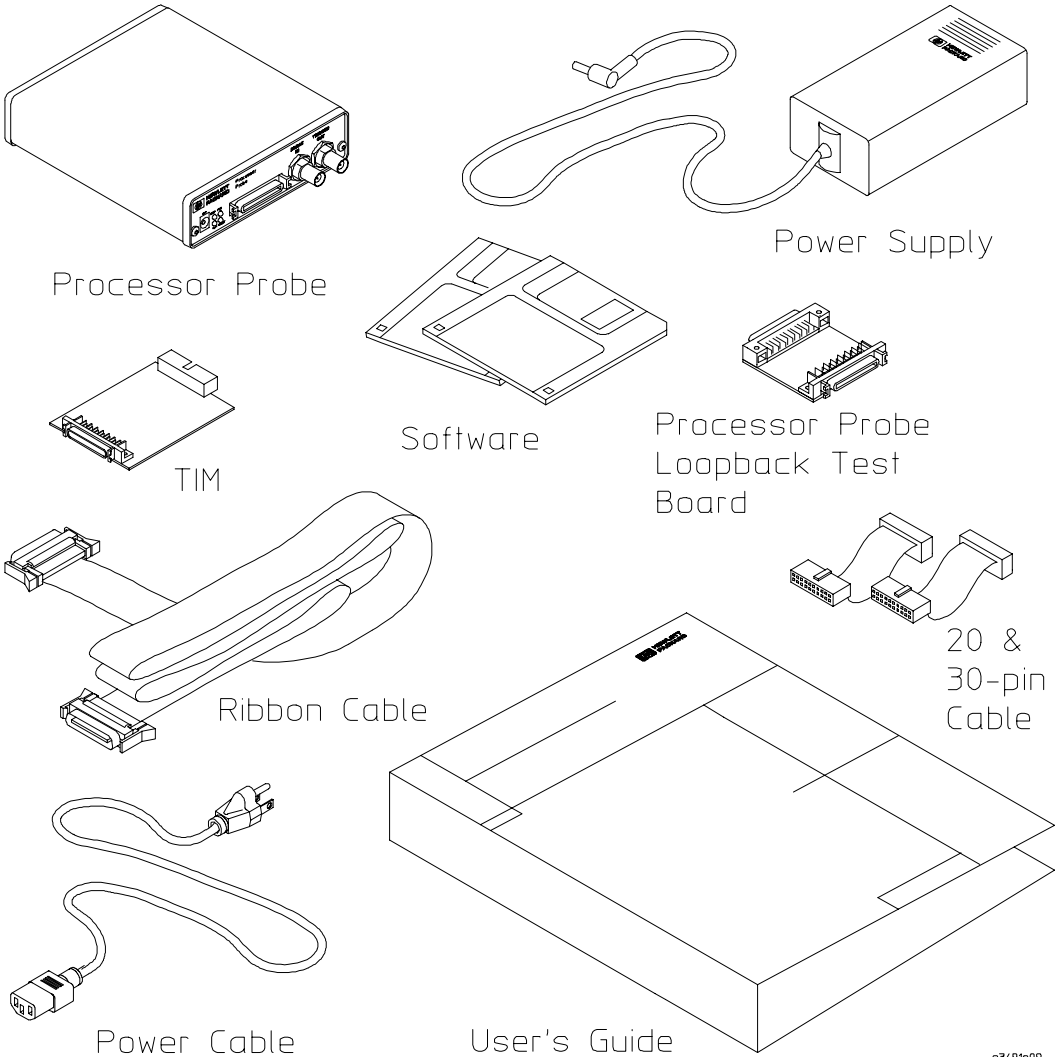

e3491e09

Equipment Supplied

- A processor probe.
- A 12V power supply for the processor probe.
- A power cord.
- A target interface module (TIM) circuit board (HP part number E3491-66504).
- A processor probe loopback test board (HP part number E3496-66502).
- Firmware for the processor probe and/or updated software for the Run Control tool on a 3.5-inch disk, if required.
- A 50-pin ribbon cable (connects the processor probe to the target interface module).
- A 20-conductor and a 30-conductor ribbon cable (connects the target interface module to your target system).
- This *User's Guide*.

Minimum Equipment Required

For run control of a Pentium target system, you need all of the following items in addition to the items listed on the previous page:

- A target system with the appropriate connector. The target system must meet the criteria on page 51.
- A LAN cable.
- A serial cable (for troubleshooting).
- An HP 16505A prototype analyzer or a PC or a workstation.

System Configurations

HP Prototype Analyzer

You can use an HP 16505A prototype analyzer connected to an HP 16500B or HP 16500C logic analysis system to analyze bus activity (via a preprocessor) and to control processor execution (via the processor probe). This is the easiest way to configure the processor probe. When the prototype analyzer's Run Control tool is not connected to the processor probe, you may connect a debugger to the processor probe.

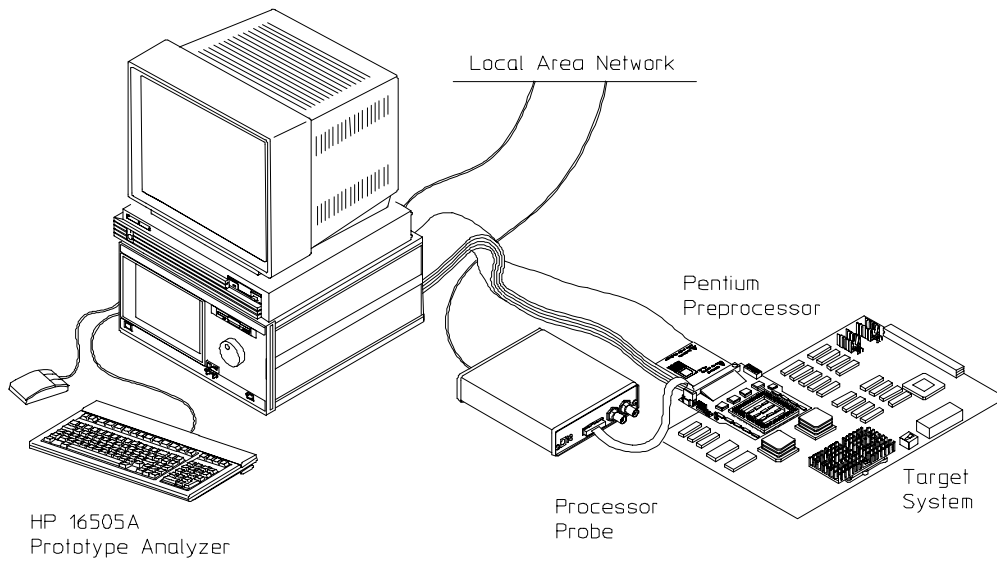

e3491e12

HP Logic Analyzer

You can connect an HP logic analyzer to your target system via a preprocessor to analyze bus activity. To control processor execution via the processor probe, you will need to use a debugger. If your debugger doesn't provide a way to configure the processor probe, you will need to use the built-in configuration commands via a telnet connection.

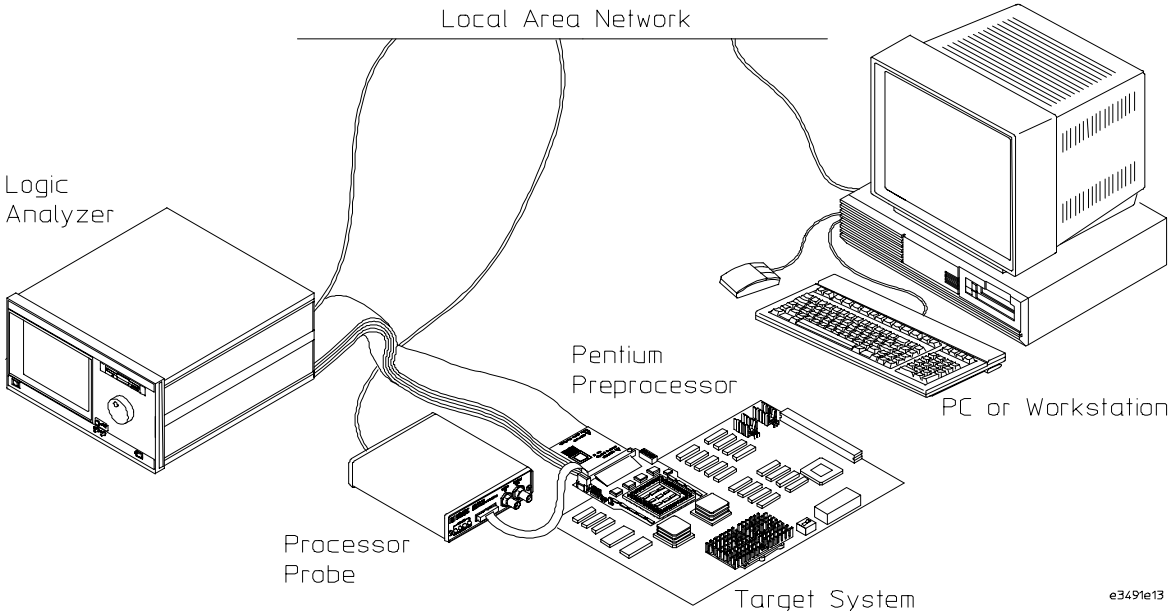

No Logic Analyzer

With no logic analyzer or preprocessor connected, you will not be able to analyze bus activity, but you can still use a debugger to control processor execution (including setting breakpoints and reading/writing registers and memory). If your debugger doesn't provide a way to configure the processor probe, you will need to use the built-in configuration commands via a telnet connection.

Power-On/Power-Off Sequence

To power on the system

With all components connected, power on your system as follows:

- 1** Logic analyzer, if you are using one.
 - 2** Processor probe (see page 9).
 - 3** Your target system.
-

To power off the system

Power off your system as follows:

- 1** Your target system.
 - 2** Processor probe.
 - 3** Logic analyzer, if you have one.
-

To connect the processor probe to a power source

The processor probe does not have an On/Off switch. To power on the processor probe:

- 1 Connect the power cord to the power supply and to a socket outlet.

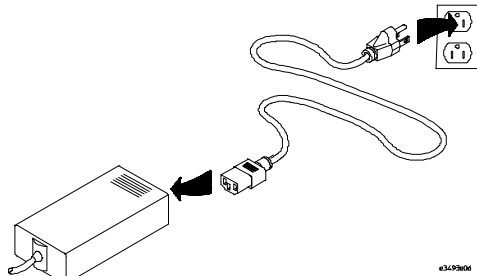

- 2 Connect the 12V power cord to the back of the processor probe.

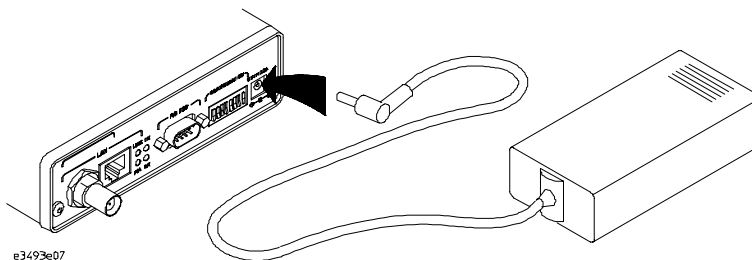

The power light on the target side of the processor probe will be illuminated.

The processor probe is shipped from the factory with a power supply and cord appropriate for your country. If the cord you received is not appropriate for your electrical power outlet type, contact your Hewlett-Packard sales and service office.

Warning

Use only the supplied HP power supply and cord.
Failure to use the proper power supply could result in electric shock.

Caution

Use only the supplied HP power supply and cord.
Failure to use the proper power supply could result in equipment damage.

Connection Sequence

Disconnect power from the target system, processor probe, and logic analyzer before you make or break connections.

- 1** Connect the processor probe to the host computer (page 11) or to the prototype analyzer (page 27).
- 2** Connect the processor probe to your target system (page 35).
- 3** Configure the processor probe (page 35).

Connecting the Processor Probe to a PC or Workstation

Connecting the Processor Probe to a PC or Workstation

You can connect your PC or workstation to the processor probe via a serial or LAN connection.

Serial connection

A serial connection allows you to complete all of the performance verification tests. Performance over a serial connection, especially if you are downloading code, may be unacceptably slow.

LAN connection

A LAN connection will allow you to make your measurements quickly and easily. A few of the performance verification tests cannot be run over a LAN.

Recommended connection

Use a LAN connection for routine use, and a serial connection for LAN configuration and for troubleshooting.

Setting Up a LAN Connection to a PC or Workstation

The processor probe has two LAN connectors:

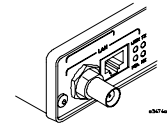

- A BNC connector that can be directly connected to a IEEE 802.3 Type 10BASE2 cable (ThinLAN). When using this connector, the processor probe provides the functional equivalent of a Medium Attachment Unit (MAU) for ThinLAN.
- An IEEE 802.3 Type 10BASE-T (StarLAN) connector.

Use either the 10BASE2 or the 10BASE-T connector. Do *not* use both. The processor probe will not work with both connected at the same time.

You must assign an IP address (Internet address) to the processor probe before it can operate on the LAN. You can also set other network parameters such as a gateway address. The IP address and other network parameters are stored in nonvolatile memory within the processor probe.

The processor probe automatically sets a subnet mask based on the subnet mask used by other devices on the network.

You can configure LAN parameters in any of the following ways:

- Using the built-in terminal interface over a serial connection. This is the most reliable method.
- Using BOOTP. BOOTP is part of the HP-UX, SunOS, and Solaris operating systems.

To obtain an IP address

1 Obtain the following information from your local network administrator or system administrator:

- An IP address for the processor probe.

You can also use a "LAN name" for the processor probe, but you must configure it using the integer dot notation (such as 127.0.0.1).

- The gateway address.

The gateway address is an IP address and is entered in integer dot notation. The default gateway address is 0.0.0.0, which allows all connections on the local network or subnet. If connections are to be made to workstations on other networks or subnets, this address must be set to the address of the gateway machine.

2 Find out whether port numbers 6470 and 6471 are already in use on your network.

The host computer interfaces communicate with the processor probe through two TCP service ports. The default base port number is 6470. The second port has the next higher number (default 6471).

The default numbers (6470, 6471) can be changed if they conflict with some other product on your network.

To change the port numbers, see page 15. If you have already set the IP address, you can use a telnet connection instead of a serial connection to connect to the processor probe.

3 Write down the link-level address of the processor probe.

You will need this address if you use BOOTP to set the IP address.

The link-level address (LLA) is printed on a label above the LAN connectors on the processor probe. This address is configured in each processor probe shipped from the factory and cannot be changed.

IP Address of Processor probe
LAN Name of Processor Probe
Gateway Address
Link-Level Address of Processor Probe

To configure LAN parameters using the built-in terminal interface

- 1 Set configuration switches S1 through S4 to CLOSED, and set the other switches as appropriate for your serial interface.

Switch settings are printed on the bottom of the processor probe. If you will use a baud rate of 9600 baud, set the switches like this:

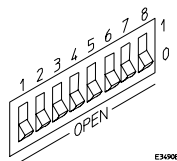

- 2 Connect an ASCII terminal (or terminal emulator) to the processor probe's RS-232 port with a 9-pin RS-232 cable.

Complete instructions for setting up a serial connection begin on page 22.

- 3 Plug in the processor probe's power cord. Press the terminal's <RETURN> key a couple times. You should see a prompt such as "p>", "?>", or "c>".

At this point, you are communicating with the processor probe's built-in terminal interface.

- 4 Display the current LAN configuration values by entering the **lan** command:

```
R>lan
lan is disabled
lan -i 0.0.0.0
lan -g 0.0.0.0
lan -p 6470
Ethernet Address : 08000903212f
```

The "lan -i" line shows the current IP address (IP address) of the processor probe.

The Ethernet address, also known as the link level address, is preassigned at the factory, and is printed on a label above the LAN connectors.

- 5 Enter the following command:

```
lan -i <internet> [-g <gateway>] [-p <port>]
```

The lan command parameters are:

-i <internet> The IP address which you obtained from your network administrator.

- g <gateway> The gateway address. Setting the gateway address allows access outside your local network or subnet.
- p <port> This changes the base TCP service port number.

The default numbers (6470, 6471) can be changed if they conflict with some other product on your network. TCP service port numbers must be greater than 1024. If you change the base port, the new value must also be entered in the /etc/services file on the host computer. For example, you could modify the line:

```
hp64700    6470/tcp
```

The IP address and any other LAN parameters you change are stored in nonvolatile memory and will take effect the next time the processor probe is powered off and back on again.

6 Disconnect the power cord from the processor probe, and connect the processor probe to your network.

This connection can be made by using either the 10BASE-T connector or the 10BASE2 (BNC) connector on the processor probe. Do not use both connectors at the same time.

7 Set the configuration switches to indicate the type of connection that is to be made.

Switch S1 must be set to OPEN, indicating that a LAN connection is being made.

Switch S5 should be CLOSED if you are connecting to the BNC connector:

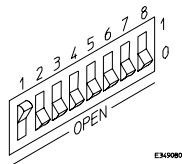

Switch S5 should be OPEN if you are connecting to the 10BASE-T connector:

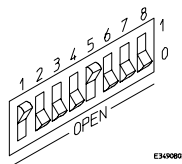

Set all other switches to CLOSED.

8 Connect the power cord to the processor probe.

9 Verify your processor probe is now active and on the network. See "To verify LAN communications" on page 21.

Once you have set a valid IP address, you can use the telnet utility to connect to the processor probe, and use the lan command to change LAN parameters.

Example

To assign an IP address of 192.6.94.2 to the processor probe, enter the following command:

```
R>lan -i 192.6.94.2
```

Now, cycle power on the processor probe so that the new address will take effect.

See Also

"Solving Problems," page 69, if you have problems verifying LAN communication.

To configure LAN parameters using BOOTP

Use this method only on a workstation which is running bootpd, the BOOTP daemon.

1 Make sure that BOOTP is enabled on your host computer.

If the following commands yield the results shown below, the BOOTP protocol is enabled:

```
$ grep bootp /etc/services
bootps      67/udp
bootpc      68/udp
$ grep bootp /etc/inetd.conf
bootps dgram udp wait root /etc/bootpd bootpd
```

If the commands did not yield the results shown, you must either add BOOTP support to your workstation or use a different method to configure the processor probe LAN parameters.

2 Add an entry to the host BOOTP database file, /etc/bootptab. For example:

```
# Global template for options common to all HP 64700
# emulators and Processor Probes.
# Use a different gateway addresses if necessary.
hp64700.global:\
    :gw=0.0.0.0:\
    :vm=auto:\
    :hn:\
    :bs=auto:\
    :ht=ether

# Specific emulator entry specifying hardware address
# (link-level address) and ip address.
hprobe.div.hp.com:\
    :tc=hp64700.global:\
    :ha=080009090B0E:\
    :ip=192.6.29.31
```

In this example, the "ha=080009090B0E" identifies the link-level address of the processor probe. The "ip=192.6.29.31" specifies the IP address that is assigned to the processor probe. The node name is "hprobe.div.hp.com".

3 Connect the processor probe to your network.

This connection can be made by using either LAN connector on the processor probe.

4 Set the configuration switches to indicate the type of connection that is to be made.

Switch S1 must be set to OPEN, indicating that a LAN connection is being made.

Switch S6 must be set to OPEN to enable BOOTP mode.

Switch S5 should be set to CLOSED if you are connecting to the BNC connector

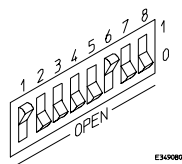

Switch S5 should be set to OPEN if you are connecting to the 10BASE-T connector.

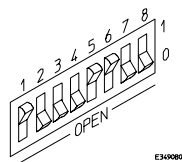

Set all other switches to CLOSED.

5 Connect the power cord to the processor probe.

Verify that the power light stays on after 10 seconds.

The IP address will be stored in EEPROM.

6 Set switch S6 back to CLOSED.

Do this so that the processor probe does not request its IP address each time power is cycled. The IP address is stored in EEPROM, so BOOTP does not need to be run again. Leaving this switch on will result in slower performance, increased LAN traffic, and even failure to power up (if the BOOTP server becomes inactive).

7 Verify your processor probe is now active and on the network. See "To verify LAN communications" on page 21.

See Also

For additional information about using bootpd, refer to the bootpd (1M) man page.

To set the 10BASE-T configuration switches

Set switches S7 and S8 to CLOSED unless one of the following conditions is true:

- **If the LAN cable exceeds the standard length, set switch S7 to OPEN.**
The processor probe has a switch-selectable, twisted-pair receiver threshold. With switch S7 set to OPEN, the twisted-pair receiver threshold is lowered by 4.5 dB. This should allow you to use cable lengths of up to about 200 meters. If you use a long cable, you should consult with your LAN cabling installer to ensure that:
 - The device at the other end of the cable has long cable capability, and
 - The cable is high-grade, low-crosstalk cable with crosstalk attenuation of greater than 27.5 dB.

When switch S7 is set to CLOSED, the LAN port operates at standard 10BASE-T levels. A maximum of 100 meters of UTP cable can be used.

- **If your network doesn't support Link Beat integrity checking or if the processor probe is connected to a non 10BASE-T network (such as StarLAN) set this switch to LINK BEAT OFF (0 or OPEN).**

In normal mode (switch S8 set to CLOSED), a link integrity pulse is transmitted every 15 milliseconds in the absence of transmitted data. It expects to receive a similar pulse from the remote MAU. This is the standard link integrity test for 10BASE-T networks. If your network doesn't support the Link Beat integrity checking or if the Software Probe is used on a non 10BASE-T network (such as StarLAN) set this switch to LINK BEAT OFF (OPEN).

Note

Setting switch S8 to OPEN when Link Beat integrity checking is required by your network will cause the remote MAU to disable communications.

To verify LAN communications

- 1 Verify your processor probe is now active and on the network by issuing a **telnet** to the IP address.

This connection will give you access to the processor probe's built-in terminal interface.

- 2 To view the LAN parameters, enter the **lan** command at the terminal interface prompt.

- 3 To exit from this telnet session, type <CTRL>D at the prompt.

The best way to change the processor probe's IP address, once it has already been set, is to telnet to the processor probe and use the terminal interface **lan** command to make the change. Remember, after making your changes, you must cycle power or enter a terminal interface **init -p** command before the changes take effect. Doing this will break the connection and end the telnet session.

If You Have Problems

If you encounter problems, refer to the "Problems" chapter (page 69).

Example

```
$ telnet 192.35.12.6

R>lan
lan is enabled
lan -i 192.35.12.6
lan -g 0.0.0.0
lan -p 6470
Ethernet Address : 08000F090B30
```

Setting Up a Serial Connection

To set up a serial connection, you will need to:

- Set the serial configuration switches
- Connect a serial cable between the host computer and the processor probe
- Verify communications

Serial connections on a workstation

If you are using a UNIX workstation as the host computer, you need to use a serial device file. If a serial device file does not already exist on your host, you need to create one. Once it exists, you need to ensure that it has the appropriate permissions so that you can access it. See the system documentation for your workstation for help with setting up a serial device.

Serial connections on a PC

Serial connections are supported on PCs. You must use hardware handshaking if you will use the serial connection for anything other than setting LAN parameters.

If you are using a PC as the host computer, you do not need to set up any special files.

To set the serial configuration switches

- 1 Set switch S1 to CLOSED (RS-232).
- 2 Set switches S2-S4 to CLOSED.
- 3 Set switch S5 to CLOSED (HW HANDSHAKE ON) if your serial interface uses the DSR:CTS/RTS lines for flow control. Set S5 to OPEN (HW HANDSHAKE OFF) if your serial interface uses software flow control (XON/XOFF).

If your serial interface supports hardware handshaking, you should use it (set switch S5 to CLOSED). Hardware handshaking will make the serial connection much more reliable.

- 4 Set switches S6-S8 for the baud rate you will use. These switch settings are listed on the bottom of the processor probe.

The higher baud rates may not work reliably with all hosts and user interfaces. Make sure the baud rate you choose is supported by your host and user interface.

Example

To use a baud rate of 9600 baud, set the switches as follows:

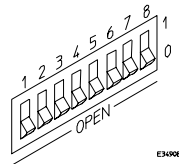

To connect a serial cable

CAUTION

Use a grounded, shielded cable. If the cable is not shielded, or if the cable is not grounded at the serial controller, the processor probe may be damaged by electrostatic discharge.

Connect an RS-232C modem cable from the host computer to the processor probe. The recommended cable is HP part number C2932A. This is a 9-pin cable with one-to-one pin connections.

If you want to build your own RS-232 cable, follow the pinout shown in the following figure:

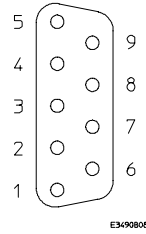

Serial Cable Pinout

Pin Number	Signal	Signal Description
1	DCD	Data Carrier Detect (not used)
2	TD	Transmit Data (data coming from HP processor probe)
3	RD	Receive Data (data going to HP processor probe)
4	DTR	Data Terminal Ready (not used)
5	GND	Signal Ground
6	DSR	Data Set Ready (Output from HP processor probe)
7	RTS	Request to Send (Input to HP processor probe)
8	CTS	Clear to Send (connected to pin 6)
9	RING	Ring Indicator (not used)

To verify serial communications

1 Start a terminal emulator program on the host computer.

If you are using a PC, the Terminal application in Microsoft Windows will work fine.

If you are using a UNIX workstation, you can use a terminal emulator such as `cu` or `kermit`.

2 Plug the power cord into the processor probe.

When the processor probe powers up, it sends a message (similar to the one that follows) to the serial port and then displays a prompt:

```
Copyright (c) Hewlett-Packard Co. 1987
All Rights Reserved.  Reproduction, adaptation, or translation without prior
written permission is prohibited, except as allowed under copyright laws.
```

```
HPE3499A Series Emulation System
Version:  A.07.06 06May97
Location:  Generics
```

```
HPE3491A Pentium(tm) Processor Probe Emulator
Version:  A.02.15 16Jul97
```

R>

The version numbers may be different for your processor probe.

3 Press the Return or Enter key a few times.

You should see a prompt such as "p>", "C>", or "?>".

For information about the commands you can use, enter `?` or `help` at the prompt.

See Also "Problems with the Serial Interface," page 79.

Setting up Debugger Software

Before you can use a debugger with the processor probe, you may need to configure some communication parameters, including the LAN address which you assigned to the processor probe.

If you have an HP 16505A prototype analyzer, use the Run Control tool to configure the processor probe. End the Run Control tool session before you start the debugger.

Do not use the Run Control tool at the same time as a debugger.

See Also

Refer to the documentation for your debugger for more information on connection the debugger to the processor probe.

Connecting the Processor
Probe to an HP 16505A
Prototype Analyzer

Connecting to an HP 16505A Prototype Analyzer

To use the processor probe you need to:

- Install the HP E3491A/B software (Run Control Tool) in the HP 16505A Prototype Analyzer, if needed
- Connect the processor probe to a power source
- Connect the processor probe to the HP 16505A via a LAN or direct connection

For a list of the parts supplied with the processor probe, see page 3.

Connecting the Probe to the Prototype Analyzer

The processor probe can be connected directly to the prototype analyzer for a point-to-point connection, or it can be connected via a LAN. The LAN connection allows remote operation; it also allows a probe to be shared by more than one prototype analyzer.

The following sections describe the connections for point-to-point and LAN configurations.

Connecting for a point-to-point configuration

The point-to-point connection is technically a LAN connection, with only two nodes.

- Use a point-to-point 10Base-T LAN cable (such as HP part number 5061-7342) to connect the processor probe directly to the prototype analyzer.
- The configuration switches must be set for a LAN configuration. Switch 1 must be set to OPEN, indicating that a LAN connection is being made. Since this is a 10BASE-T connection, switch 5 must also be set to OPEN.
- Use the procedure in "Setting Up LAN Communication" to set the Ethernet address, IP address, and gateway address.

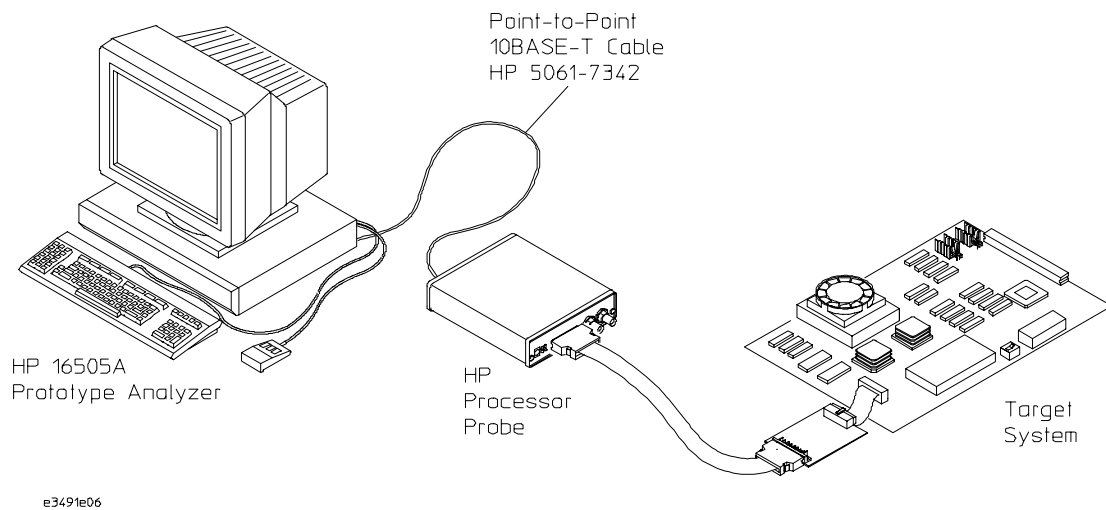

Point-to-point Connection

Connecting to a LAN

The processor probe has two LAN connectors:

- A BNC connector that can be directly connected to an IEEE 802.3 Type 10BASE2 cable (ThinLAN). When using this connector, the processor probe provides the functional equivalent of a Medium Attachment Unit (MAU) for ThinLAN.
- An IEEE 802.3 Type 10BASE-T (StarLAN) connector.

Caution

Use either the 10BASE2 or the 10BASE-T connector. Do *not* use both. The processor probe will not work with both connected at the same time.

The configuration switches must be set for a LAN configuration. Switch 1 must be set to OPEN, indicating that a LAN connection is being made. For 10BASE-T connections, switch 5 must also be set to OPEN. Refer to "To set the 10BASE-T configuration switches" for additional information on configuring 10BASE-T switches.

Use the procedure in "Setting Up LAN Communication" to set the Ethernet address, IP address, and gateway address.

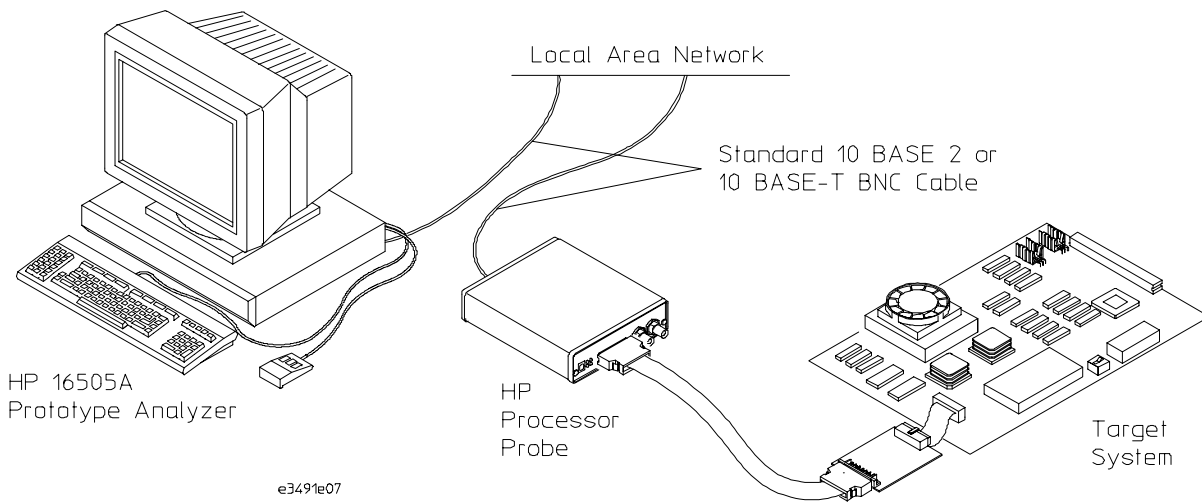

LAN Connection

To set the 10BASE-T configuration switches

Set switches S7 and S8 to CLOSED unless one of the following conditions is true:

- **If the LAN cable exceeds the standard length, set switch S7 to OPEN.**
The processor probe has a switch-selectable, twisted-pair receiver threshold. With switch S7 set to OPEN, the twisted-pair receiver threshold is lowered by 4.5 dB. This should allow you to use cable lengths of up to about 200 meters. If you use a long cable, you should consult with your LAN cabling installer to ensure that:
 - The device at the other end of the cable has long cable capability, and
 - The cable is high-grade, low-crosstalk cable with crosstalk attenuation of greater than 27.5 dB.

When switch S7 is set to CLOSED, the LAN port operates at standard 10BASE-T levels. A maximum of 100 meters of UTP cable can be used.

- **If your network doesn't support Link Beat integrity checking or if the processor probe is connected to a non 10BASE-T network (such as StarLAN) set this switch to LINK BEAT OFF (0 or OPEN).**

In normal mode (switch S8 set to CLOSED), a link integrity pulse is transmitted every 15 milliseconds in the absence of transmitted data. It expects to receive a similar pulse from the remote MAU. This is the standard link integrity test for 10BASE-T networks. If your network doesn't support the Link Beat integrity checking or if the processor probe is used on a non 10BASE-T network (such as StarLAN) set this switch to LINK BEAT OFF (OPEN).

Note

Setting switch S8 to OPEN when Link Beat integrity checking is required by your network will cause the remote MAU to disable communications.

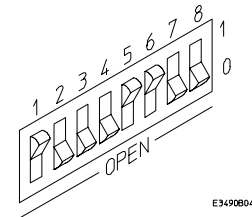
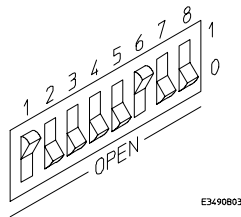

Switch Positions for LAN (left) and 10BASE-T LAN (right) Configurations, S6 Open for Initialization

Setting Up LAN Communication

To use the processor probe on a LAN, you must assign an IP address (Internet address) an Ethernet address, and a gateway address. The IP address and other network parameters are stored in nonvolatile memory within the processor probe. These addresses must be initialized for either point-to-point or LAN connections.

The processor probe automatically sets the subnet mask based on the subnet mask used by other devices on the network.

To set the LAN address of the processor probe using the Run Control tool

- 1** Set the configuration switch S6 on the processor probe to OPEN. Cycle power to reconfigure the probe. Switch 6 causes the probe to continuously broadcast a search message over the network.
- 2** Drag the "uP Run Control" tool from the toolbox onto the HP 16505A prototype analyzer workspace.
- 3** Move the mouse cursor over the icon, press the right mouse button, and select "Init Probe LAN Addresses...".
- 4** Enter the Ethernet address, IP address, and the gateway address in the appropriate fields, then select Set Addresses.

Use the processor probe Ethernet address. This address is on a sticker labeled "LLA" (for "link-level address") on the processor probe.

For point-to-point connections, use an IP address that is one greater than or one less than the HP 16505A IP address (for example, the prototype analyzer default address is 192.0.2.231, so use 192.0.2.230 or 192.0.2.232).

For LAN connections, obtain an IP address from your local network administrator or system administrator.

The gateway address is an IP address and is entered in integer dot notation. For point-to-point connections, just leave this field blank. If connections are to be made to workstations on other networks or subnets, this address must be set to the address of the gateway machine. Obtain that address from your local network administrator or system administrator.

- 5 Set the configuration switch S6 back to CLOSED, then power down the probe. When the probe is powered down and then powered up, it will be configured for the new LAN parameters.**

See also

"Setting Up the Processor Probe on Your LAN" in the on-line help for the uP Run Control tool.

To verify LAN communications

Start a user session to verify your processor probe is now active and on the network.

- 1** Drag the uP Control Tool from the toolbox to the workspace.
- 2** Move the mouse cursor over the uP Control Tool in the workspace, press and hold the right mouse button, move the cursor over Start Session..., and release the mouse button.

See also

"Starting Sessions" in the on-line help for the uP Run Control tool.

If You Have Problems

If you encounter problems, refer to the "Problems" chapter (page 69).

If you are having difficulty establishing LAN connections and need to perform the LAN performance verification tests, you will need a serial connection to a PC or a workstation.

Connecting to the Target System

Connecting to a Target System

The E3491B Pentium processor probe can be connected to a target system by the methods listed below.

- Directly through the Intel defined 20- or 30-pin debug connector.
- Through the HP E2457A Pentium Preprocessor Interface.
- Through a custom designed interface.

This chapter describes the procedures to connect to the Intel defined debug connectors and the E2457A Pentium preprocessor. To design a custom interface refer to "Designing a target system for use with the Intel-defined debug interface" on page 53.

To test the HP E3491B Pentium processor probe

If this is the first time that you have used the E3491B Pentium processor probe, you should run the built-in performance verification test before you connect to a target system. Refer to the "Problems" chapter (page 69) for information on performance verification.

To connect to a target system via the Intel defined debug port

If the target system has been designed with the Intel defined 20- or 30-pin debug port, the HP E3491B Pentium probe should be connected to the target system using one of the 20- or 30-conductor cable assemblies provided.

- 1** Remove power from the target system and the processor probe.
- 2** Plug one end of the 50-pin cable into the processor probe.
- 3** Plug the other end of the 50-pin cable into the target interface module.
- 4** Plug the 30-pin connector end of the 20- or 30-conductor cable into the target interface module.

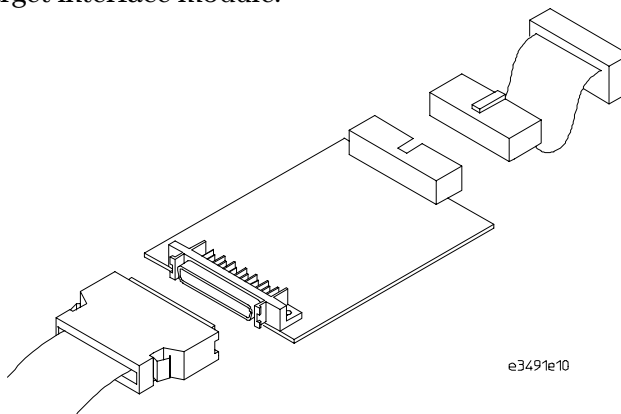

- 5 If you are using the 20-conductor assembly, plug the 20-pin connector end of the cable assembly into the 20-pin debug port in the target system.

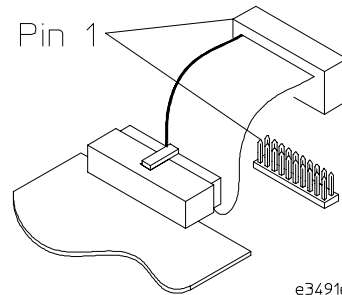

- 6 If you are using the 30-conductor assembly, plug the 30-pin connector end of the cable assembly into the 30-pin debug port in the target system.

Note that pins 21 - 30 are not used by the HP E3491B; the probe does not support the dual processor capability of the 30-pin debug port.

- 7 Turn on the power to the probe, then turn on the power to the target system.

To connect to a target system via the HP E2457A Pentium Preprocessor

If the target system does not have either the 20- or 30-pin Intel-defined debug port, the HP E3491 Pentium processor probe can be connected to the target system through the HP E2457A Pentium Preprocessor Interface. The 64762-61602 cable assembly is used to connect the DBRESET signal from the HP E3491B Pentium processor probe because DBRESET is not a Pentium processor pin. In target systems where it is not known if there are target system resources driving the TCK, TDI, TDO, TMS, TRST, PRDY or R/S# signals, the target system signals can be isolated from the processor by removing the associated pins from one of the pin protectors on the bottom side of the E2457A Pentium Preprocessor.

To connect to the target system:

- 1** Remove power from the target system, logic analyzer and the probe.
- 2** Plug one end of the 50-pin cable into the processor probe.
- 3** Plug the other end of the 50-pin cable into the target interface module.
- 4** Plug the 30-pin connector end of the 20-conductor cable assembly into the target interface module.
- 5** Plug the 20-pin connector end of the 20-conductor cable assembly into the 20-pin debug connector of the HP E2457A Pentium Preprocessor.
- 6** Connect the 2-conductor cable assembly to J3 or J6 of the E2457A Pentium Preprocessor. J3 provides a high system reset to the target system. J6 provides a low true system reset to the target system.
- 7** Connect the free leads from the 2-conductor cable assembly to the target system reset circuitry.
- 8** Power up the processor probe, then the logic analyzer, then the target system.

Configuring the Processor Probe

Configuring the Processor Probe

The HP processor probe has a number of user configurable parameters. These parameters may be customized for specific target systems and saved in configuration files for future use.

The easiest way to configure the processor probe is through the Run Control tool in the HP 16505A prototype analyzer.

If you use the Run Control tool, please refer to the online help in the Configuration window for information on each of the configuration options.

Other ways to configure the processor probe are:

- the processor probe's built-in terminal interface
- your debugger

To configure using the Run Control tool

If you are using the processor probe with an HP 16505A prototype analyzer, you can use the Run Control tool to configure the processor probe.

1 Start a Run Control tool session.

Drag the "uP Run Control" tool from the toolbox onto the HP 16505A prototype analyzer workspace. Next, move the mouse cursor over the icon, press the right mouse button, and select "Start Session...".

2 Open a Configuration window.

Select "Configuration..." from the tool menu or from the Window menu in any uP Run Control tool window.

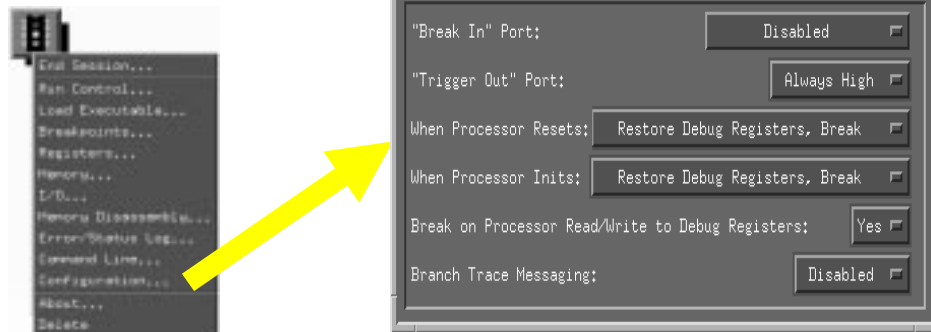

3 Set the configuration options, as needed.

The configuration selections will take effect when you close the configuration window or when you move the mouse pointer outside the window.

4 Save the configuration settings.

If you like, you can save the configuration settings as part of a workspace. To save the configuration settings, save the workspace by selecting **File**→**Save Workspace As...** from the prototype analyzer's main menu.

See Also

Help →**Help on this window** in the Configuration window for information on each of the configuration options.

Help in the Run Control tool menu for help on starting a uP Run Control session.

To configure using the built-in commands

If you are unable to configure the processor probe with the Run Control tool or a debugger interface, you can configure the processor probe using the built-in "terminal interface" commands.

- 1** Connect a terminal or terminal emulator to the processor probe's serial port, or use a telnet session over the LAN.
- 2** Enter `cf` to see the current configuration settings.
- 3** Use the `cf` command to change the configuration settings.

See Also

Enter `help cf` for help on the configuration commands.

For information on connecting a serial terminal or terminal emulator, see page 22.

For information on other built-in commands, see page 74.

Example

To see a description of the "restrict to real-time runs" option, type:

```
help cf rrt
```

To enable the "restrict to real-time runs" mode, type:

```
cf rrt=yes
```

To configure using a debugger

Because the HP processor probe can be used with several third-party debuggers, specific details for sending the configuration commands to the probe cannot be given here. However, all debuggers should provide a way of directly entering terminal mode commands to the probe. Ideally, you would create a file that contains the configuration entries you need modified that can be sent to the probe at the beginning of each debugger session. See your debugger manual for more details.

To configure restriction to real-time runs

Real-time runs configuration

Value	Processor probe configured for	Built-in command
no	Allows commands which break to the monitor. Examples include commands which display memory or registers. These commands break to the monitor to access the target processor, then resume the user program. (Default)	<code>cf rrt=no</code>
yes	No commands are allowed which break to the monitor, except "break," "reset," "run," or "step." The processor must be explicitly stopped before these commands can be performed.	<code>cf rrt=yes</code>

If your debugger allows displaying or modifying memory or registers while the processor is running, you must set `rrt=no` in order to use this feature.

To configure the Trigger Out BNC

Trigger out configuration

Value	The Trigger Out BNC will	Built-in command
fixhigh	Always be high	<code>cf trigout=fixhigh</code>
fixlow	Always be low	<code>cf trigout=fixlow</code>
monhigh	Go high when the processor is running in background (Default)	<code>cf trigout=monhigh</code>
monlow	Go low when the processor is running in background	<code>cf trigout=monlow</code>

To configure the Trigger In BNC

Trigger in configuration

Value	Meaning	Built-in command
off	Inputs to the Break In BNC will be ignored.	<code>cf breakin=off</code>
rising	The processor probe will cause a break on a rising edge. (Default)	<code>cf breakin=rising</code>
falling	The processor probe will cause a break on a falling edge.	<code>cf breakin=falling</code>

There is a delay between receiving the edge and stopping the processor.

To configure branch trace messaging

Branch trace messaging

Value	Meaning	Built-in command
Disabled	No Branch Trace Message special cycles are generated. (Default)	<code>cf bratrcmsg=nocycle</code>
One Cycle	The Branch Trace Message cycle is the address for the instruction causing the taken branch.	<code>cf bratrcmsg=onecycle</code>
Two Cycles	The Branch Trace Message cycles are the address for the instruction causing the taken branch and the target address.	<code>cf bratrcmsg=twocycle</code>

To configure breaks on processor read/write to debug registers

Debug registers

Value	Processor probe configured for	Built-in command
no	Any program reads or writes to the debug registers do not cause a break. The read or write completes successfully. (Default)	<code>cf brkwrdbg=no</code>
yes	Any program reads or writes to the debug registers will cause a break. The actual read or write will not be performed.	<code>cf brkwrdbg=yes</code>

To configure INIT behavior

This configuration option specifies how the processor probe behaves when the Pentium processor's INIT input signal is asserted (without the processor's RESET input signal being asserted).

INIT

Value	Meaning	Built-in command
Restore Debug Registers, Break	An INIT without RESET will break into monitor. Debug registers will be restored. (Default)	<code>cf initworeset=break</code>
Do Not Restore Debug Registers, Run	An INIT without RESET will not break into monitor. Debug registers will not be restored.	<code>cf initworeset=continue</code>
Restore Debug Registers, Run	An INIT without RESET will break into monitor. Debug registers will be restored, and the user program will begin running.	<code>cf initworeset=start</code>

To configure RESET behavior

This configuration option specifies how the processor probe behaves when the Pentium processor's RESET input signal is asserted.

RESET

Value	Meaning	Built-in command
Restore Debug Registers, Break	A RESET will break into monitor. Debug registers will be restored. (Default)	<code>cf reset=break</code>
Do Not Restore Debug Registers, Run	A RESET will not break into monitor. Debug registers will not be restored.	<code>cf reset=continue</code>
Restore Debug Registers, Run	A RESET will break into monitor. Debug registers will be restored, and the user program will begin running.	<code>cf reset=restart</code>

These actions occur only when the RESET signal transitions from high to low.

When a reset command is sent to the processor probe, the processor probe asserts RESET continuously until another command causes RESET to be deasserted.

Designing a Target System

Designing a Target System

This chapter will help you design a target system that will work with the HP E3491B Pentium processor probe.

Designing a target system for use with the HP E2457A Preprocessor Interface

The following should be considered when designing a target system for use with the HP E3491B via the HP E2457A Pentium Preprocessor:

- The TCK, TDI, TMS, TDO, TRST#, R/S# and PRDY target system signals should not require more than 3 ma. at 2.4V or more than 4 ma. at 0.5V. Excessive trace lengths on these signals should be avoided.
- Target system circuitry should not actively drive TCK, TDI, TMS, TRST or R/S#.

If necessary, all of the signals above can be disconnected from the target system by removing the following pins from one of the pin protectors on the bottom of the E2457A Pentium Preprocessor.

TCK (pin M34), TMS (pin P34), TDI (pin N35), TDO (pin N33), TRST# (pin Q33), R/S# (pin AC35), PRDY (pin AC05)

- To enable the E3491B Pentium processor probe to reset the target system, an input to the target system reset circuitry must be provided. This can be connected to the target system by the 2-conductor cable assembly (HP part number 64762-61602). A high true reset is available from J3 of the HP E2457A. J3 can source 3 ma at 2.4 v and sink 4 ma at 0.5V. A low true reset is available from J6 of the HP E2457A. J3 can source 3 ma at 2.4V and can sink 64 ma at 0.55V.

Designing a target system for use with the Intel-defined debug port

For information about designing an Intel defined debug port refer to "Pentium Family User's Manual" Volume 1 chapter 31. (Intel order #241428-003).

In addition, the following should be considered when designing a target system for use with the Intel defined debug port.

- The Vcc from the target system should sourced from the Pentium Vcc not +5 volts.
- The second processor in the 30-pin debug port definition is not currently supported by the HP E3491B.
- Only one device, the Pentium processor, is allowed in the boundary scan path when the HP E3491B is connected.

For a pinout of the debug port, refer to the Specifications and Characteristics (page 60).

Planning INIT and RESET operation

Note that the processor probe's "action upon reset" behavior happens only after RESET is deasserted.

If INIT and RESET are asserted at the same time, or at almost the same time, the processor will only be reset. Remember to wait until the reset is complete before asserting INIT.

See pages 48 and 49 for information on configuring what actions the processor probe should take after a RESET or an INIT.

APIC interrupts

The processor probe does not break operation when an interrupt is issued from the APIC. APIC interrupts should be disabled when you are using the processor probe.

Specifications and Characteristics

Processor Compatibility

The HP E3491B Pentium processor probe supports the Pentium microprocessors at iCOMP INDEX 735/90 and 815/100.

Electrical Specifications

BNC, labeled TRIGGER OUT

Output Drive Logic high level with 50-ohm load ≥ 2.0 V. Logic low level with 50-ohm load ≤ 0.4 V. Output function is selectable—see the Configuration chapter (page 41).

BNC, labeled BREAK IN

Input Edge-triggered TTL level input, 20 pf, with 2K ohms to ground in parallel. Maximum input: 5 V above V_{CC} ; 5 V below ground. Input function is selectable—see the Configuration chapter (page 41).

Communications

Serial Port 9-pin female type “D” subminiature connector. RS-232 DCE to 115.2 kbaud.

10BASE-T LAN Port RJ-45 connector. IEEE 802.3 10BASE-T (StarLAN).

10BASE 2 LAN Port 50-ohm BNC connector. IEEE 802.3 10BASE2 (ThinLAN). When using this connector, the HP E3491B processor probe provides the functional equivalent of a Medium Attachment Unit (MAU) for ThinLAN.

Power Supply

Input 100-240 V, 9.75 A, 50/60 Hz, IEC 320 connector.

Output 12 V, 3.3 A

Accessory Power Out 12 V, 3.0A, center negative

Maximum Ratings

Characteristics for HP E3491B Pentium processor probe	Notes	Symbol	Min	Max	Unit
Input voltage range (Vcct only)	1, 2	V _{in}	-0.3	5.5	V
Input voltage range (All others)		V _{in}	-0.5	5.5	V
Input Current (Vcct only)		I _{ii}		15	μA
Input High Voltage (except Vcct)	3	V _{ih}	2.0		V
Input Low Voltage (except Vcct)	3	V _{il}		0.8	V
Input High Current	3	I _{ih}		-15	μA
Input Low Current	3	I _{il}		100	μA
Output High Voltage	4	V _{oh}	2.4	Vcct + 0.5	V
Output Low Voltage	4	V _{ol}		0.5	V
Output High Current	4	I _{oh}	3		mA
Output Low Current	4	I _{ol}	-4		mA

Notes

1 Vcct = target system microprocessor voltage

2 When connected to a Pentium 735/90 or 815/100 this voltage should not exceed the Vcc of the microprocessor

3 INIT, PRDY, RESET, TDO

4 TCK, TDI, TMS, TRST#, R/S#, DBRESET

Chapter 7: Specifications and Characteristics
Electrical Specifications

Characteristics for HP E2457A Pentium Preprocessor, J3 and J6	Notes	Symbol	Min	Max	Unit
Output High Voltage (J3 only)	5	V _{oh}	2.4	V _{cct} + 0.5	V
Output Low Voltage (J3 only)	5	V _{ol}		0.5	V
Output High Current (at V _{oh} , J3 only)	5	I _{oh}	3		mA
Output Low Current (at V _{ol} , J3 only)	5	I _{ol}	-4		mA
Output High Voltage (J6 only)	6	V _{oh}	2.4	5.0	V
Output Low Voltage (J6 only)	6	V _{ol}		0.55	V
Output High Current (at V _{oh} , J6 only)	6	I _{oh}	3		mA
Output Low Current (at V _{ol} , J6 only)	6	I _{ol}	-64		mA

Notes

5 J3 = DBRESET from the HP E3491B

6 J6 = inverted DBRESET from the HP E2457A

Environmental Specifications

Temperature

Operating, 0 to +40 °C (+32 to +104 °F); nonoperating, -40 to +60 °C (-40 to +140 °F).

Altitude

Operating/nonoperating 4600 m (15 000 ft).

Relative Humidity

15% to 95%.

Pinout for 30-pin Debug Port

Pin Number	Pin Name	HP E3491 Usage
1	INIT	INIT signal from the target system
2	DBRESET	Reset output from the HP E3491B
3	RESET	RESET signal from the target system
4	GND	
5	not connected	
6	VCC	Vcc from the Pentium microprocessor
7	R/S# 1	R/S# signal from the target system
8	GND	
9	not connected	
10	GND	
11	PRDY 1	PRDY signal from the target system
12	TDI	JTAG signal
13	TDO	JTAG signal
14	TMS	JTAG signal
15	GND	
16	TCK	JTAG signal
17	GND	
18	TRST#	JTAG signal
19	DBINST#	Grounded when the target debug port is connected to the HP E3491B
20	BSEN#	Grounded when the target debug port is connected to the HP E3491B
21	PRDY 2	Not supported by the HP E3491B
22	GND	
23	R/S# 2	Not supported by the HP E3491B
24 - 28	not connected	
29	GND	
30	not connected	

Updating Firmware

Updating Firmware

Hewlett-Packard formally supports only configurations that include the latest revisions of all software and firmware. Software updates can be ordered to get the latest firmware revisions.

You can update the firmware in the HP processor probe by using the prototype analyzer Run Control tool or by running the `prgflash.xxx` utility program.

Four different versions of the `prgflash` program are available. The program `prgflash.hp7` runs on HP-UX Series 700 machines, `prgflash.sun` runs on Sun SPARC machines running SunOS 4.1, `prgflash.sol` runs on Sun SPARC machines running Solaris and `prgflash.exe` runs on Windows[®] machines. The `prgflash.xxx` utility will only update the firmware over lan.

The floppy disk is in MS-DOS format and can be read directly on MS-DOS machines, HP-UX Series 700 and Solaris machines equipped with a 3.5 inch floppy drive.

See the "readme" file on the floppy disk for any special instructions regarding the firmware.

To update firmware using the HP prototype analyzer

The easiest way to update the firmware in your HP processor probe is to use the Run Control tool.

- 1** End any run control sessions which may be running.
- 2** Install the firmware onto the prototype analyzer hard disk, if necessary.
- 3** Move the mouse cursor over the Run Control tool in the workspace, press and hold the right mouse button, move the mouse cursor over *Update Probe Firmware...*, and release the right mouse button.
- 4** In the Update Probe Firmware dialog, enter the LAN name or address of the processor probe, then click *Update Firmware*.
- 5** When the firmware has been updated, cycle power on the processor probe.

See Also

The Run Control tool online help for instructions on how to copy the firmware files to the prototype analyzer hard disk.

To update firmware using prgflash.xxx

- 1 Make a directory on your computer, change to that directory and copy the files from the floppy to that directory.

On HP-UX Series 700 machines, if your machine is equipped with a floppy drive, copy the file install.hp7 to this directory with the doscp command and execute it as follows:

```
mkdir myprobe
cd myprobe
doscp <floppy device>:install.hp7 .
./install.hp7 <floppy device>
```

Where <floppy device> is the name of the floppy raw device file, typically "/dev/rdisk/0s1".

On SUN Solaris machines, insert the floppy in the drive, run volcheck to "mount" the volume and copy the files to the current directory.

```
volcheck
mkdir myprobe
cd myprobe
cp /floppy/floppy0/* .
eject
```

On SUN SunOS 4.1 machines, there are no standard utilities for reading MS-DOS format floppies. To find out if there are any non-standard means of reading PC format floppies on your machine, check with your system administrator.

For MS-DOS machines, you can run prgflash.exe copy the files from the floppy drive to a directory on your hard drive.

```
md c:\myprobe
a:
copy *.* c:\myprobe
```

For all UNIX machines that do not have floppy drives, you can copy the files from a LAN based PC using a LAN based file transfer utility like ftp or rcp, see your network administrator or LAN software documentation. Use binary mode when transferring the files from MS-DOS machines.

- 2 Run the **prgflash.xxx** command.

To run prgflash.xxx on Unix workstations

Use the command:

```
prgflash.xxx [-v] [probe IP addr] [product to update]
```

where xxx is hp7, sun or sol as described above.

The -v option means "verbose". It causes progress status messages to be displayed during operation.

The probe IP addr option is the ip address of the HP processor probe in either dotted decimal form or alias form (from /etc/hosts).

The product to update option names the products whose firmware is to be updated. Check the "readme" file on the disk for more details.

If you enter the prgflash.xxx command without all options, it becomes interactive. You must always supply the "probe IP addr" option. If you don't include the "product to update" option, it displays the products which have firmware update files on the system and asks you to choose one. It will first look in the current directory for product files, if it does not find any there, it will check the directory \$HP64000/inst/update if the \$HP64000 environment variable is set or /usr/hp64000/inst/update if \$HP64000 is not set. You can abort the interactive prgflash.xxx command by pressing <CTRL>c.

Example

To use update the firmware in "myprobe" from a series 700 HP-UX machine, you could enter the following command:

```
prgflash.hp7 -v myprobe E3491
```

To run prgflash.exe on Windows 95 or Windows NT

In an MS-DOS window, use the command:

```
prgflash [-v] [probe IP addr] [product to update]
```

The -v and [product to update] options are the same as described above.

The [probe IP addr] option is the ip address of the HP processor probe in dotted decimal form or alias form (if a hosts file has been set up on the PC).

You can enter prgflash without any options and you will be prompted for the IP address and "product to update" option. It will first look in the current directory for product files, if it does not find any there, it will check the directory \$HP64700\update if the \$HP64700 environment variable is set or

\\hp64700\update if \$HP64700 is not set. You can abort the interactive prgflash.exe command by pressing <CTRL>c.

This version of prgflash will only run under Windows 95 or Windows NT. If you only have access to MS-DOS or Windows 3.1, contact HP.

Example

To use update the firmware, you could enter the following command:

```
prgflash -v 192.5.21.2 E3491
```

Prgflash.xxx will print "Flash programming SUCCEEDED" and return 0 if it is successful; otherwise, it will print "Flash programming FAILED" and return a nonzero (error).

You can verify the update by displaying the firmware version information.

To display current firmware version information

- Use **telnet** or a terminal emulator to access the built-in "terminal interface" and use the **ver** command to view the version information for firmware currently in the HP processor probe.

If the firmware doesn't appear to be updated

Though Flash EPROM is very reliable, it can fail. If the HP processor probe determines the Flash EPROM is not working, it will try to use the boot code in its Flash EPROMs. The only useful operation the boot code allows is running prgflash.

- Make sure the current version information is correct by comparing it with the version numbers of the update software.
- Try updating the firmware again.

If none of these steps solves the problem, contact your local HP Representative.

If there is a power failure during a firmware update

If there is a power glitch during a firmware update, some bits may be lost during the download process, possibly resulting in an HP processor probe that will not boot up.

- Set switch S4 to OPEN, then cycle power. This tells the HP processor probe to ignore everything in the Flash EPROM except the boot code.
- Repeat the firmware update process.
- Set switch S4 to CLOSED, then cycle power. This restores the HP processor probe to its normal mode.

Solving Problems

Solving Problems

If you have problems with the processor probe, your first task is to determine the source of the problem. Problems may originate in any of the following places:

- The connection between the processor probe and your workstation, PC, or HP 16505A prototype analyzer
- The processor probe itself
- The connection between the processor probe and the target system
- The target system

You can use several means to determine the source of the problem:

- The troubleshooting guide on the next page
- The status lights on the processor probe
- The processor probe "performance verification" tests
- The processor probe's built-in "terminal interface" commands

Troubleshooting Guide

Common problems and what to do about them

Symptom	What to do	See also
Host computer reports LAN connection problems	Follow the checklist in the "If you have LAN problems" section.	page 76
Commands from the Run Control tool or debugger have no effect	1 Verify LAN communication. 2 Use a telnet connection (or serial connection) to try a few built-in commands. If this works, your debugger may not be configured properly. If this does not work, continue with the next procedure....	page 21 page 74
Processor probe built-in commands do not work	1 Check that the processor probe has been properly configured for your target system. 2 Run the processor probe performance verification tests. 3 If the performance verification tests pass, then there is an electrical problem with the connection to the target processor OR the target system may not have been designed according to "Designing a Target System."	page 41 page 83 page 51
"Slow or missing clock" message after a logic analyzer run	Check that the target system is running user code or is in reset. (This message can appear if the processor is in background mode.)	
Some commands fail	Check the "restrict to real-time runs" configuration	page 45

Status Lights

The processor probe communicates various modes and error conditions via the status lights. The meanings of the status lights are shown on the previous page.

The following table gives more information about the meaning of the power and target status lights.

○ = LED is off

● = LED is on

* = Not applicable (LED is off or on)

Power/Target Status Lights

Pwr/Target LEDs	Meaning
○ ○	Processor probe is not connected to power supply
○ ○	
○ ●	No target system power, or processor probe is not connected to the target system
○ ○	
○ ●	Target system is in a reset state
○ ●	
● ●	Only boot firmware is good (other firmware has been corrupted)
● ○	
● ●	The target processor is executing in Debug Mode
○ ○	
○ ●	The target processor is executing user code
● ○	

Processor probe status lights

The following illustration shows the status lights on both sides of the processor probe and what they mean:

Lit when the power supply is properly connected to the processor probe

Lit when the target processor is running in debug mode

Lit when the target processor is running in normal (user program) mode

Lit when the target system is in a reset state

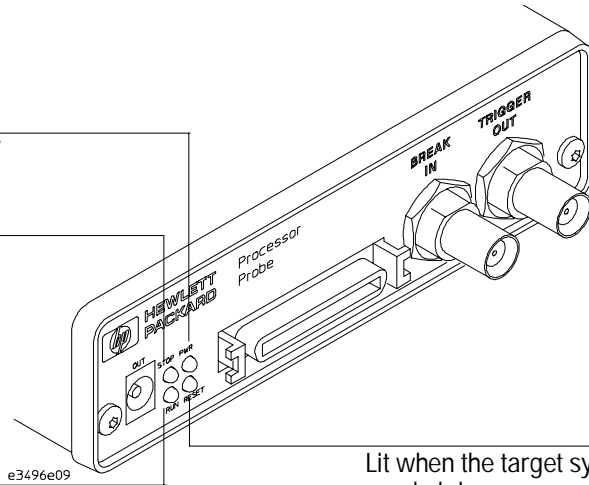

Lit when LAN data is being transmitted

Lit when 10BASE-T connection has a good link; not used for 10BASE2

Lit when the polarity on the receive twisted pair is reversed for a 10BASE-T connection

Lit when LAN data is being received

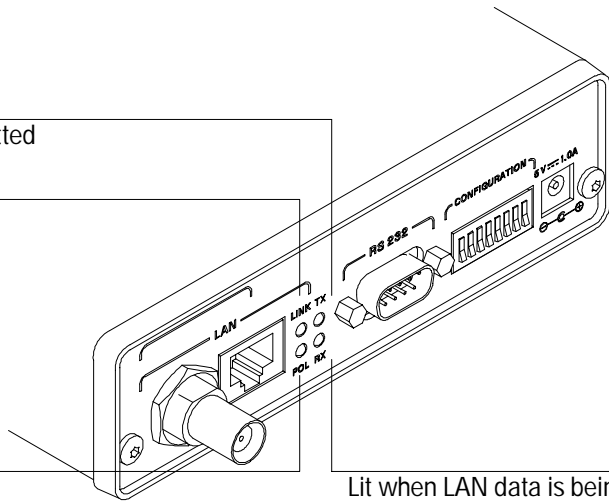

Figure 7. Status Lights

Built-in Commands

The processor probe has some built-in "terminal interface" commands which you can use for troubleshooting.

You can access the terminal interface via:

- A serial connection (see page 22)
- A telnet (LAN) connection
- The Command Line window in the Run Control tool
- A "debugger command" window in your debugger

Here are a few useful commands:

Useful built-in commands

b	Break—go into the background monitor state
cf	Configuration—read or write configuration options
help	Help—display online help for built-in commands
init	Initialize—init -c reinitializes everything in the processor probe except for the LAN software; init -p is the equivalent of cycling power (it will break LAN connections)
lan	configure LAN address
m	Memory—read or write memory
reg	Register—read or write a register
r	Run—start running user code
rep	Repeat—repeat a command or group of commands
rst	Reset—reset the target processor (the processor probe will wait for you to press the target's RESET button)
s	Step—do a low-level single step
ver	Version—display the product number and firmware version of the processor probe

The prompt indicates the status of the processor probe:

Processor probe prompts

U	Running user program
M	Running in background monitor
r	Target is reset
R	Emulation reset
p	No target power
?	Unknown state

Examples

To set register GPR0, then view GPR0 to verify that it was set, enter:

```
reg gpr0=ffff  
reg gpr0
```

To break execution then step a single instruction, enter:

```
b  
s
```

To determine what firmware version is installed in the processor probe, enter:

```
ver
```

See Also

Use the `help` command for more information on these and other commands. Note that some of commands listed in the help screens may not be available. If you are writing your own debugger, contact HP for more information.

Problems with the LAN Interface

If you cannot verify LAN communication

If you cannot verify connection using the procedure in "To verify LAN communication", or if the commands are not accepted by the processor probe:

- Make sure that you have connected the processor probe to the proper power source and that the power light is lit.
- Make sure that you wait for the power-on self test to complete before connecting.
- Make sure that the LAN cable is connected. Watch the LAN LED's to see whether the processor probe is seeing LAN activity. Refer to your LAN documentation for testing connectivity.
- Make sure that only one of the LAN ports is connected.
- Make sure the processor probe communication configuration switches are set correctly. Unplug the processor probe power cord, then plug it in again to make sure the switch settings are read correctly by the processor probe.
- Check that the Run Control Tool or debugger was configured with the correct LAN address. If the processor probe is on a different subnet than the host computer, check that the gateway address is correct.
- Make sure that the processor probe's IP address is set up correctly. Use the RS-232 port to verify this that the IP address is set up correctly. When you are connected to the RS-232 port, run performance verification on the processor probe's LAN interface with the "pv" command.

- It's also possible for there to be a problem with the processor probe firmware while the LAN interface is still up and running. In this case, you must reboot the processor probe by disconnecting power to the processor probe and reconnecting it again.
- Use a serial connection to run the LAN performance verification tests (see page 83).

If you have LAN connection problems

- If the processor probe does not accept commands from the prototype analyzer:
 1. Check that switch S1 is "0" (attached to LAN, not RS-232).
 2. Check that switch S5 is in the correct position for your LAN interface (either 10BASE2 or 10BASE-T).(Remember: if you change any switch settings, the changes do not take effect until you cycle power.)
- If the processor probe still does not respond, you need to verify the IP address and gateway mask of the processor probe. To do this, connect the processor probe to a terminal or terminal emulator (see page 22), change the switch settings so it is connected to RS-232, and enter the "lan" command. The output looks something like this:

```
lan -i 15.5.24.116
lan -g 15.5.23.1
lan -p 6470
Ethernet Address : 08000909BAC1
```

"lan -i" shows the internet address is 15.5.24.116 in this case. If the Internet address (IP) is not what you expect, you can change it with the 'lan -i <new IP>' command.

"lan -g" shows the gateway address. Make sure it is the address of your gateway if you are connecting from another subnet, or 0.0.0.0 if you are connecting from the local subnet.

"lan -p" shows the port is 6470. If the port is not 6470, you must change it with the "lan -p 6470" command (unless you have deliberately set the port number to a different value because of a conflict).

If the "POL" LED is lit

The "POL" LED indicates that the polarity is reversed on the receive pair if you are using a 10BASE-T connection. The processor probe should still work properly in this situation, but other LAN devices may not work.

If it takes a long time to connect to the network

- Check the subnet masks on the other LAN devices connected to your network. All of the devices should be configured to use the same subnet mask.

Subnet mask error messages do not indicate a major problem. You can continue using the processor probe.

The processor probe automatically sets its subnet mask based on the first subnet mask it detects on the network. If it then detects other subnet masks, it will generate error messages.

If there are many subnet masks in use on the local subnet, the processor probe may take a very long time to connect to the network after it is turned on.

To "clean up" the network, connect a terminal to the processor probe. You can then see error messages which will help you identify which devices on the network are using the wrong subnet masks.

Problems with the Serial Interface

If you cannot verify RS-232 communication

If the processor probe prompt does not appear in the terminal emulator window:

- Make sure that you have connected the processor probe to the proper power source and that the power light is lit.
- Make sure that you have properly configured the data communications switches on the processor probe and the data communications parameters on the host computer. You should also verify that you are using the correct cable.

The most common type of data communications configuration problem involves the configuration of the processor probe as a DTE device instead of as a DCE device. If you are using the wrong type of cable, no prompt will be displayed.

A cable with one-to-one connections will work with a PC or an HP Series 700 workstation.

If you have RS-232 connection problems with the MS Windows Terminal program

- Remember that Windows 3.1 only allows two active RS-232 connections at a time. To be warned when you violate this restriction, choose Always Warn in the Device Contention group box under 386 Enhanced in the Control Panel.
- Use the "Terminal" program (usually found in the Accessories windows program group) and set up the "Communications..." settings as follows:

```
Baud Rate: 9600 (or whatever you have chosen for the
emulator)
Data Bits: 8
Parity: None
Flow Control: hardware
Stop Bits: 1
```

When you are connected, hit the Enter key. You should get a prompt back. If nothing echos back, check the switch settings on the processor probe.

- If the switches are in the correct position and you still do not get a prompt when you hit return, try turning OFF the power to the processor probe and turning it ON again.
- If you still don't get a prompt, make sure the RS-232 cable is connected to the correct port on your PC, and that the cable is appropriate for connecting the PC to a DCE device.

With certain RS-232 cards, connecting to an RS-232 port where the processor probe is turned OFF (or is not connected) will hang the PC. The only way to get control back is to reboot the PC. Therefore, we recommend that you always turn ON the processor probe before attempting to connect via RS-232.

Problems with the Processor Probe Itself

To run the power up self test

- 1 Unplug the processor probe, then plug it in.
- 2 Watch the status lights. They should show the following pattern:
 - = LED is off
 - = LED is on
 - * = Not applicable (LED is off or on)

Normal sequence during power up self test

	Pwr/Target LEDs	Meaning
1	○● ○○	Initial power up, system reset
2	○● ○○	XILINX array initialized successfully
3	○● ●○	XILINX array tested successfully
4	●● ○○	BOOT ROM space tested successfully
5	○● ●○	GENERIC ROM space tested successfully
6	●● ○○	DRIVER ROM space tested successfully
7	○● ●○	RESERVED ROM space tested successfully
8	●● ○○	RAM tested successfully
9	○● ●○	LAN internal feedback tested successfully

	Pwr/Target LEDs	Meaning
10	○● ○○	Boundary scan master (BSM) test begun
11	●● ●○	BSM test completed, start system, load drivers, initialize LAN

If the power up self test fails, the RESET LED will flash the number of the test, then stay lit.

If any of the LEDs fail to change, or all of them remain on, there is a system failure.

Following power up, the LEDs will enter one of the following states:

○● ○○	No target system power, or the processor probe is not connected to the target system, or
●● ○○	Target system is executing in Debug Mode
○● ○●	Target system is in a reset state
○● ●○	Target system is running user code
●● ●●	Target system is in an unknown state
●● ●○	Only the boot ROM was used; other firmware in the Flash EPROM has been corrupted

Starting a user interface will change the pattern to the one requested by the interface.

If the power up self tests fail, try the following:

- Check and reset the LAN address. LAN powerup failures will occur if the processor probe does not have a valid Link Level Address and IP Address.
- Disconnect all external connections, including the LAN, serial (RS-232), and BNC Break and Trigger cables, then cycle power.
- To ensure that the firmware is working as it should, reprogram the firmware, then cycle power.

To execute the built-in performance verification test

In addition to the powerup tests, there are several additional performance verification (PV) tests available.

Some of these tests can be performed through the prototype analyzer. The LAN tests can only be executed through the RS-232 port.

To fully test the processor probe, you will need to run the PV test with several hardware configurations:

- For the BREAK IN, TRIGGER OUT BNC FEEDBACK TEST, connect a coaxial cable between BREAK IN and TRIGGER OUT.
- For the TARGET PROBE FEEDBACK TEST, connect the processor probe loopback test board (HP part number E3496-66502).

To perform PV tests through the HP 16505A prototype analyzer

- 1 End any Run Control tool sessions.
- 2 Disconnect the 50-pin cable from the processor probe, and plug the processor probe loopback test board (HP part number E3496-66502) into the processor probe.
- 3 From the Run Control tool menu, open the Performance Verification window.
- 4 Enter the LAN address of the processor probe.
- 5 Select the number of iterations to perform.
- 6 Click **Start PV**.

The results will appear on screen.

To perform complete PV tests

The LAN tests can only be executed through the RS-232 port. The remainder of this section assumes that the tests are being run from a terminal emulator connected to the RS-232 port.

- 1** Disconnect the 50-pin cable from the processor probe, and plug the processor probe loopback test board (HP part number E3496-66502) directly into the processor probe. Do not plug anything into the other end of the processor probe loopback test board.

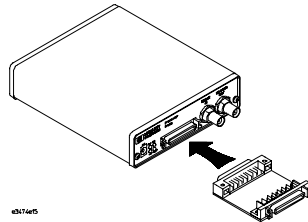

On a good system, when the feedback connector is plugged into the target connector, the RESET LED will light and the BKG and USER LEDs will be out.

- 2** Connect a coaxial cable between BREAK IN and TRIGGER OUT.
- 3** Set all of the switches to CLOSED.

This is standard RS-232 at 9600 baud which can be connected directly to a 9 pin RS-232 interface that conforms to the IBM PC-AT 9 pin standard.

- 4** Use a terminal emulator to connect to the processor probe.
- 5** Enter the **pv 1** command.

Note that all of the tests cannot be executed at once. Tests 4, 5, and 6 require the loopback test board, which cannot be connected at the same time as the 50-pin cable.

See Also

Options available for the "pv" command are explained in the help screen displayed by typing "help pv" or "? pv" at the prompt.

Examples:

Here are some examples of ways to use the **pv** command.

To execute both tests one time:

```
pv 1
```

To execute test 2 with maximum debug output repeatedly until a ^C is entered:

```
pv -t2 -v9 0
```

To execute tests 3, 4, and 5 only for 2 cycles:

```
pv -t3-5 2
```

The results on a good system, with the BNC's connected, and with the loopback test board connected, are as follows:

```
c>pv 1
```

```
Testing: HPE3499A Series Emulation System
  Test # 1: Powerup PV Results                passed!
  Test # 2: LAN 10Base2 Feedback Test         passed!
  Test # 3: LAN 10BaseT Feedback Test        passed!
  Test # 4: Break In and Trigger Out BNC Feedback Test passed!
  Test # 5: Target Probe Feedback Test       passed!
  Test # 6: Boundary Scan Master Test        passed!
PASSED Number of tests: 1          Number of failures: 0
```

```
Copyright (c) Hewlett-Packard Co. 1987
```

```
Copyright (c) International Business Machines Corp. 1995
```

```
All Rights Reserved.  Reproduction, adaptation, or translation without prior
written permission is prohibited, except as allowed under copyright laws.
```

```
HPE3499A Series Emulation System
```

```
Version:  A.06.00 14Feb96
```

```
Location:  Generics
```

```
HPE3491A Pentium(tm) Processor Probe Emulator
```

```
Version:  A.02.15 16Jul97
```

```
?>
```

You may get an error like "ERROR 172! Bad status code (0xff) from the hard reset sequence" just before the prompt. This is because the selftest loopback connector is installed instead of being connected to a real target system. You will also get either a "c>" or "?>" prompt for the same reason, this is normal and expected. Any errors after the "PASSED Number of tests: 1 Number of failures: 0" line can be ignored.

If a performance verification test fails

There are some things you can do if a failure is found on one of these tests. Details of the failure can be obtained through using a verbose level of 2 or more.

If the particular failure you see is not listed below, contact HP for assistance.

TEST 2: LAN 10BASE2 Feedback Test failed

For LAN 10BASE2 test, the following is an example of a failure which is *not* caused by a broken processor probe.

```
R>pv -t2 -v2 1
```

```
Testing: HPE3499A Series Emulation System
  Test # 2: LAN 10Base2 Feedback Test                failed!
    FAILED - no lan connection (LAN probably not terminated)
FAILED Number of tests: 1          Number of failures: 1
```

Check to see that the port under test has a good cable connected to it and that the cable is properly terminated with a 50 ohm terminator on each end of the overall cable.

```
R>pv -t2 -v2 1
```

```
Testing: HPE3499A Series Emulation System
  Test # 2: LAN 10Base2 Feedback Test                failed!
    FAILED due to excessive collisions
FAILED Number of tests: 1          Number of failures: 1
```

The most common cause of this problem is poor termination of the cable or failure to remove the port under test from the LAN before performing the test. Check to see that the terminators are good (50 Ohms) and that you are isolated from any traffic on a system LAN.

```
R>pv -t2 -v2 1
```

```
Testing: HPE3499A Series Emulation System
  Test # 2: LAN 10Base2 Feedback Test                failed!
    FAILED - invalid Ethernet address in EEPROM
FAILED Number of tests: 1          Number of failures: 1
```

First check to see that a correct LLA and IP address have been set in the virtual EEPROM through the "lan" command. If the "lan" command shows bad information for the LLA and IP, then try to set them to correct values. If you are unable to set them to correct values, there is a failure in the FLASH ROM which requires service from HP.

Test 3: 10BaseT Feedback Test failed

```
R>pv -t3 -v2 1
```

```
Testing: HPE3499A Series Emulation System
  Test # 3: LAN 10BaseT Feedback Test          failed!
FAILED  Number of tests: 1                    Number of failures: 1
```

In addition to the internal checks performed in Test 2, this test also checks for shorts on the cable connected to the network. If this test fails, disconnect the cable and run the test again. If it then passes, the cable is faulty. If it still fails, it requires service from HP.

If the processor probe passes this "pv" test, additional testing can be performed through exercising the connection to the network. To run this test, set configuration switch 1 and switch 5 to OPEN, all other configuration switches CLOSED (this enables LAN using 10BaseT). Cycle power and wait for 15 to 30 seconds. Then "ping" the processor probe from your host computer or PC. See the LAN documentation for your host computer for the location and action of the "ping" utility. If the processor probe fails to respond to the "ping" request, verify that the lan parameters (IP address and gateway address) are set correctly and that your host computer recognizes the IP address of the processor probe. If all else is good, then failure to respond to ping indicates a faulty processor probe.

Test 4: Break In and Trigger Out BNC Feedback Test

```
R>pv -t4 -v2 1
```

```
Testing: HPE3499A Series Emulation System
  Test # 4: Break In and Trigger Out BNC Feedback Test  failed!
  Break In not receiving Break Out HIGH
FAILED  Number of tests: 1                    Number of failures: 1
```

Before returning to HP, check to ensure that you have connected a good Coaxial cable between the two BNCs. If the cable is good, the processor probe is bad.

TEST 5: Target Probe Feedback Test

A verbose output on this test can be extensive. For example, the following is the output of this test if you forget to plug in the processor probe loopback test board.

```
p>pv -t5 -v2 1
```

```
Testing: HPE3499A Series Emulation System
Test # 5: Target Probe Feedback Test                                     failed!
  Bad 20 Pin Status Read when unconnected = 0x7fb7
                                Expected Value = 0xffb7
  Bad 20 Pin Status Read when connected= 7fb7
                                Expected Value = 0x7fb7
  Output 19 Low not received on Input 11
  Output 11 Low not received on Input 19
  Output 13 Low not received on Input 1
  Output 12 High not received on Input 6
  Output 12 and Input 6 not pulled high on release
  Output 8 Low not received on Input 10
  Output 7 Low not received on Input 20
  Output 4 Low not received on Input 14
  Output 2 Low not received on Input 18
FAILED Number of tests: 1          Number of failures: 1
```

If the you get a verbose output like this, check to make sure that the loopback test board was connected properly.

TEST 6: Boundary Scan Master Test

TEST 7: I2C Test

TEST 8: Data Lines Test

If these tests are not executed, check that you have connected the processor probe loopback test board.

If these tests fail, return the processor probe to HP for replacement.

Returning the Parts to Hewlett-Packard for Service

To return a part to Hewlett-Packard

- 1** Follow the procedures in this chapter to make sure that the problem is caused by a failure in the processor probe or power supply, not by configuration or communication problems.
- 2** Call your nearest HP sales office. Ask them for the address of the nearest HP service center.
A list of HP sales offices is included at the back of this binder.
- 3** Package the part and send it to the HP service center.
Keep any parts which you know are working. For example, if only the power supply is broken, keep the target interface module, processor probe and cables.
- 4** When the part has been replaced, it will be sent back to you.
The unit returned to you will have the same serial number as the unit you sent to HP.

To obtain replacement parts

The repair strategy for this emulation solution is board replacement. The following table lists some parts that may be replaced if they are damaged or lost. Contact your nearest Hewlett-Packard Sales Office for further information on servicing the board.

Exchange assemblies are available when a repairable assembly is returned to Hewlett-Packard. These assemblies have been set up on the "Exchange Assembly" program. This allows you to exchange a faulty assembly with one that has been repaired, calibrated, and performance verified by the factory. The cost is significantly less than that of a new assembly.

Part numbers

Exchange Assemblies

Part Number	Description
E3491-69402	Programmed processor probe

Replacement Assemblies

Part number	Description
0950-3043	Power Supply
E3491-61601	20-conductor target cable
E3491-61602	30-conductor target cable
E3496-61601	50-pin data cable
E3496-66502	Processor probe loopback test board
E3491-66504	Target interface module (TIM)

To clean the processor probe

If the processor probe requires cleaning:

- 1** Remove power from the instrument.
- 2** Clean with a mild detergent and water.
- 3** Make sure that the instrument is completely dry before reconnecting it to a power source.

- A**
address, IP
 See IP address
altitude specifications, 59
APIC interrupts, 53
- B**
BKG light, 73
BNC
 break in, 46
 LAN, 13, 31
 trigger out, 46
BNC, LAN, 56
BOOTP, 18–19
branch trace messaging,
 enabling/disabling, 47
break on program reads or writes to debug registers, 47
breakpoints, restoration on INIT without RESET, 48
breakpoints, restoration on RESET, 49–50
built-in commands
 configuration, 44
 LAN configuration, 15–17
 list of commands, 74–75
- C**
cable
 LAN, 20, 32
 power, 9
 replacing, 90
 serial, 23–24
cf commands, 44
cleaning, 90
clocks
 specifications, 56–58
configuration, 41–50
configuration, system, 5–7
connecting to the target system, 35–40
connection
 host workstation, 11–26
 problems, LAN, 77
 problems, RS-232, 79
 prototype analyzer, 27–34
 sequence, 10
connector
- 10BASE-T, 13, 56
10BASE2, 13, 56
serial, 56
current specifications, 57
- D**
data communications
 specifications, 56
DBRESET signal, 39
DCE or DTE selection and RS-232 cable, 79
debug port, designing, 53, 60
debug registers, break on program reads or program writes to, 47
debugger
 configuration, 44
 setting up, 26
 writing, 75
- E**
equipment supplied, 3
ethernet address, 15
- F**
files
 workstation setup, 26
firmware version, 66
firmware, updating, 62
flash EPROM, 62
- G**
gateway address, 16, 77
- H**
host computer
 connecting to, 11–26
HP 16505A prototype analyzer, 27–34
- I**
IEEE 802.3, 13, 33
INIT signal, 53
INIT without RESET, specifying action on, 48
internet address
 See IP address
interrupts, APIC, 53
IP address, 13–15, 33, 76–77
- L**
lan command, 15–17
LAN connection problems, 77, 86–87
LAN interface, 13, 33
LAN parameters, configuring
 BOOTP, 18–19
 methods, 13
 prototype analyzer, 33
 terminal interface, 15–17
lights
 See status lights
link beat, 20, 32
link level address, 15, 18
LINK light, 73
logic analyzer
 configuration overview, 6
- M**
mask, subnet, 78
MAU, 13, 31, 56
monitor, 45
monitor, INIT without RESET and breaks into, 48
monitor, RESET and breaks into, 49–50
- P**
parts supplied, 3
PC
 connecting to, 11–26
 performance verification test, 83
ping command, 77
pinout, debug port, 60
point-to-point connection, 30
POL light, 73, 78
port number, 16
power cord, 9
power failure during firmware update, 67–68
power on/off sequence, 8–9
power supply, connecting, 9
power up self test, 81
prgflash, 62
problems, 69–90
program reads or writes to debug registers, break on, 47
prompts, 75
prototype analyzer
 configuration overview, 5
 connection, 27–34
-

R

real-time runs, configuring, 45
registers (debug), break on program reads
or writes to, 47
requirements
 minimum equipment, 4
RESET
 light, 73
RESET signal, 49, 53
RESET, specifying action on, 49–50
RS-232
 See serial connection
Run Control tool
 configuration, 43
 debugger conflict, 26
run control unit
 See processor probe

S

self test, 81
serial connection
 DCE or DTE selection, 79
 number of connections, 79
 problems, 79
 setting up, 22
 verifying, 25–26
service ports, TCP, 16
service, how to obtain, 89
setup
 See configuration
signals, specifications, 52, 57, 60
slow clock, 71
software probe
 See processor probe
specifications
 altitude, 59
 clock, 56–58
 data communications, 56
 temperature, 59
 trigger in/out, 56
StarLAN, 13, 20, 31–32
status lights, 72–73, 81
subnet mask, 13, 33, 77–78
switches
 bootp, 19
 LAN configuration, 15–17, 20, 30, 32
 serial configuration, 23
system configurations, 5–7

T

target system
 connecting to, 36
TCK signal, 52
telnet, 21, 76
temperature specifications, 59
terminal (MS Windows program), 79
terminal interface, 21
 See also built-in commands
 LAN parameters, setting, 15–17
ThinLAN, 13, 31, 56
trigger
 in/out specifications, 56
troubleshooting, 71
TX light, 73

U

update, firmware, 62
USER light, 73

V

version, firmware, 66
voltage specifications, 57

W

workstation
 connecting to, 11–26
workstation files, 26

© Copyright Hewlett-Packard Company 1994- 1997
All Rights Reserved.

Reproduction, adaptation, or translation without prior written permission is prohibited, except as allowed under the copyright laws.

Restricted Rights Legend.

Use, duplication or disclosure by the U.S. Government is subject to restrictions as set forth in subparagraph (c) (1) (ii) of the Rights in Technical Data and Computer Software clause at DFARS 252.227-7013 for DOD agencies, and subparagraphs (c) (1) and (c) (2) of the Commercial Computer Software Restricted Rights clause at FAR 52.227-19 for other agencies.

Hewlett-Packard Company
3000 Hanover Street
Palo Alto, California 94304
U.S.A.

Document Warranty

The information contained in this document is subject to change without notice.

Hewlett-Packard makes no warranty of any kind with regard to this material, including, but not limited to, the implied warranties of merchantability or fitness for a particular purpose.

Hewlett-Packard shall not be liable for errors contained herein or for damages in connection with the furnishing, performance, or use of this material.

Safety

This apparatus has been designed and tested in accordance with IEC Publication 1010, Safety Requirements for Measuring Apparatus, and has been supplied in a safe condition. This is a Safety Class I instrument (provided with terminal for protective earthing). Before applying power, verify that the correct safety precautions are taken (see the following warnings). In addition, note the external markings on the instrument that are described under "Safety Symbols."

Warning

- Before turning on the instrument, you must connect the protective earth terminal of the instrument to the protective conductor of the (mains) power cord. The mains plug shall only be inserted in a socket outlet provided with a protective earth contact. You must not negate the protective action by using an extension cord (power cable) without a protective conductor (grounding). Grounding one conductor of a two-conductor outlet is not sufficient protection.
- Only fuses with the required rated current, voltage, and specified type (normal blow, time delay, etc.) should be used. Do not use repaired fuses or short-circuited fuseholders. To do so could cause a shock or fire hazard.

- Service instructions are for trained service personnel. To avoid dangerous electric shock, do not perform any service unless qualified to do so. Do not attempt internal service or adjustment unless another person, capable of rendering first aid and resuscitation, is present.
- If you energize this instrument by an auto transformer (for voltage reduction), make sure the common terminal is connected to the earth terminal of the power source.
- Whenever it is likely that the ground protection is impaired, you must make the instrument inoperative and secure it against any unintended operation.
- Do not operate the instrument in the presence of flammable gasses or fumes. Operation of any electrical instrument in such an environment constitutes a definite safety hazard.
- Do not install substitute parts or perform any unauthorized modification to the instrument.
- Capacitors inside the instrument may retain a charge even if the instrument is disconnected from its source of supply.
- Use caution when exposing or handling the CRT. Handling or replacing the CRT shall be done only by qualified maintenance personnel.

Safety Symbols



Instruction manual symbol: the product is marked with this symbol when it is necessary for you to refer to the instruction manual in order to protect against damage to the product.



Hazardous voltage symbol.



Earth terminal symbol: Used to indicate a circuit common connected to grounded chassis.

WARNING

The Warning sign denotes a hazard. It calls attention to a procedure, practice, or the like, which, if not correctly performed or adhered to, could result in personal injury. Do not proceed beyond a Warning sign until the indicated conditions are fully understood and met.

CAUTION

The Caution sign denotes a hazard. It calls attention to an operating procedure, practice, or the like, which, if not correctly performed or adhered to, could result in damage to or destruction of part or all of the product. Do not proceed beyond a Caution symbol until the indicated conditions are fully understood or met.

Hewlett-Packard
P.O. Box 2197
1900 Garden of the Gods Road
Colorado Springs, CO 80901-2197, U.S.A

Product Warranty

This Hewlett-Packard product has a warranty against defects in material and workmanship for a period of one year from date of shipment. During the warranty period, Hewlett-Packard Company will, at its option, either repair or replace products that prove to be defective. For warranty service or repair, this product must be returned to a service facility designated by Hewlett-Packard.

For products returned to Hewlett-Packard for warranty service, the Buyer shall prepay shipping charges to Hewlett-Packard and Hewlett-Packard shall pay shipping charges to return the product to the Buyer. However, the Buyer shall pay all shipping charges, duties, and taxes for products returned to Hewlett-Packard from another country.

Hewlett-Packard warrants that its software and firmware designated by Hewlett-Packard for use with an instrument will execute its programming instructions when properly installed on that instrument. Hewlett-Packard does not warrant that the operation of the instrument software, or firmware will be uninterrupted or error free.

Limitation of Warranty

The foregoing warranty shall not apply to defects resulting from improper or inadequate maintenance by the Buyer, Buyer-supplied software or interfacing, unauthorized modification or misuse, operation outside of the environmental specifications for the product, or improper site preparation or maintenance.

No other warranty is expressed or implied. Hewlett-Packard specifically disclaims the implied warranties of merchantability or fitness for a particular purpose.

Exclusive Remedies

The remedies provided herein are the buyer's sole and exclusive remedies. Hewlett-Packard shall not be liable for any direct, indirect, special, incidental, or consequential damages, whether based on contract, tort, or any other legal theory.

Assistance

Product maintenance agreements and other customer assistance agreements are available for Hewlett-Packard products. For any assistance, contact your nearest Hewlett-Packard Sales Office.

Certification

Hewlett-Packard Company certifies that this product met its published specifications at the time of shipment from the factory. Hewlett-Packard further certifies that its calibration measurements are traceable to the United States National Institute of Standards and Technology, to the extent allowed by the Institute's calibration facility, and to the calibration facilities of other International Standards Organization members.

About this edition

This is the *HP E3452A PowerPC 603/603e Processor Probe User's Guide*.

Publication number
E3491-97002, July 1997
Printed in USA.

Print history is as follows:

E3491-97000, May 1995
E3491-97001, Aug 1995

New editions are complete revisions of the manual. Many product updates do not require manual changes; and, conversely, manual corrections may be done without accompanying product changes. Therefore, do not expect a one-to-one correspondence between product updates and manual updates.

UNIX is a registered trademark in the United States and other countries, licensed exclusively through X/Open Company Limited.

Windows, MS Windows, Windows NT, and MS-DOS are U.S. registered trademarks of Microsoft Corporation.

Pentium is a U.S. registered trademark of Intel Corporation.